

Analysis and attenuation of impulsive sound pressure in large caliber weapon during muzzle blast[†]

Hafizur Rehman¹, Seung Hwa Hwang¹, Berkah Fajar², Hanshik Chung³ and Hyomin Jeong^{3,*}

¹Department of Mechanical and Precision Engineering, Gyeongsang National University,
445 Inpyeong Dong, Tongyeong 650-160, Gyeongsang Nam do, Korea

²Department of Mechanical Engineering, University of Diponegoro, Semarang, Indonesia

³Department of Mechanical and Precision Engineering, Gyeongsang National University, Institute of Marine Industry,
445 Inpyeong Dong, Tongyeong 650-160, Gyeongsang Nam do, Korea

(Manuscript Received December 23, 2010; Revised June 22, 2011; Accepted June 24, 2011)

Abstract

Due to the supersonic speed at which propellant gas flows through the gun barrel, a high intensity impulsive sound pressure is created, which has negative effects in many respects. Therefore, the high pressure waves generated due to muzzle blast flow of tank gun during firing is a critical issue to examine. The purpose of this paper is to study and analyze this high pressure impulsive sound, generated during the blast flow. The large caliber 120 mm K1A1 tank gun has been selected especially for this purpose. An axisymmetric computational domain has been constructed by employing Spalart Allmaras turbulence model to evaluate pressure and sound level in the tank gun using Computation Fluid Dynamics technique. Approximately 90% of pressure and 20 dB of sound level have been attenuated due to use of the three baffle silencer at the muzzle end of the gun barrel in comparison to the tank gun without silencer. Also, the sound pressure level at different points in the ambient region shows the same attenuation in the results. This study will be helpful to understand the blast wave characteristics and also to get a good idea to design silencer for large caliber weapon system.

Keywords: Computational fluid dynamics (CFD); Silencer; Large caliber weapon system (LCWS); Impulsive sound; Muzzle blast; Decibel

1. Introduction

Due to firing of tank guns, a high intensity sound pressure is created in form of muzzle blast wave. In fact this muzzle blast is produced due to the explosion of the propellant inside the gun barrel. The deflagration of the propellant in the chamber produces an abrupt expansion of gases. This rapid increase in volume causes pressure waves which accelerate the projectile into flight from the muzzle end of the barrel and as result of this high intensity muzzle blast, impulsive sound is heard. Compared with other sound, the impulsive sound has several special features and different properties, such as low frequency, strong directivity and long range propagation [1, 2].

And because of these special features, it can easily reach surrounding areas and communities. The impulsive noise from the gun has various negative effects such as damage to human bodies, damage of structures, creates an environmental, social problem and also creates military problems such as exposure of location of troops etc.

Muzzle blast, sabot discard, projectile flight and explosion of the projectile at the target are the main factors which cause this high intensity noise. There are two main sources of impulsive noise from the firing i.e. gun blast noise and projectile bow shock noise [3].

The gun blast is highly directional therefore sound effect at the locations directly in front of the gun is about 15 decibels (dB) higher than for equidistance locations directly to the rear of the gun. The projectile bow shock noise only occurs forward of the gun, in a region determined by the supersonic velocity of the projectile. This noise is localized nearer to the gun if the slug is unstable in flight and thus decelerates quickly to subsonic speeds [3, 4]. According to some experimental investigation, the noise levels due to high pressure blast flow, could be heard about 10 miles away from the firing point at a level of 90 dB [1, 3]. Thus in view of all above facts the study of blast wave and impulsive sound attenuation is of great importance.

Silencers or mufflers are used to reduce this muzzle blast flow noise. Silencers have to be designed especially, so that it allows gun gases to expand into chamber volumes properly to get maximum pressure reduction. The attenuation generally increases with its internal volume and number of baffles but only up to a certain value and then decreases thereafter. The

[†]This paper was recommended for publication in revised form by Associate Editor Dongshin Shin

*Corresponding author. Tel.: +82 10 9548 3184, Fax.: +82 55 640 3188

E-mail address: hmjeong@gnu.ac.kr

© KSME & Springer 2011

attenuation also depends on the length of the inlet chamber, the placement of the silencer, and projectile whole size. The suppression of the muzzle blast is important in both large caliber weapon system and small caliber weapon system designs. In case of large caliber weapon system, the design of silencer has relied heavily on experimental work and the development of empirical databases [1, 8].

The study on impulsive noise is divided into two categories, noise attenuation and blast wave analysis. In present study the impulsive sound attenuation, by using a three baffle silencer during high pressure blast flow has been analyzed. For this, large caliber 120 mm K1A1 tank gun has been selected especially. As 120 mm tank gun is a main battle tank (MBT), armed with the world best technology and is very popular due to its unique characteristics and individuality having penetration capacity up to 600 mm thick armored vehicle. Therefore keeping in view its importance, this caliber MBT has been selected in this study.

For evaluation, the designing work, simulation and results, has been done by using Gambit and Fluent CFD software. The simulated results of pressure and sound pressure level at different points inside the silencer and also at different points in the ambient region have been compiled and compared with the results at the same points without using silencer.

2. Governing equation

The governing equation for Spalart, P.R. and Allmaras, S.R. turbulence model for aerodynamic flows as per Recherche Aerospatiale, No.1, 1994.pp.5-21 is expressed as,

$$\frac{\partial \hat{v}}{\partial t} + u_j \frac{\partial \hat{v}}{\partial x_j} = c_{b1}(1 - f_{t2})\hat{S}\hat{v} - \left[c_{w1}f_w - \frac{c_{b1}}{k^2}f_{t2} \right] \left(\frac{\hat{v}}{d} \right)^2 + \frac{1}{\sigma} \left[\frac{\partial}{\partial x_j} \left((v + \hat{v}) \frac{\partial \hat{v}}{\partial x_j} \right) + c_{b2} \frac{\partial \hat{v}}{\partial x_i} \frac{\partial \hat{v}}{\partial x_i} \right] + f_{t1}\Delta U^2 \quad (1)$$

where:

$$f_{t1} = c_{t1}g_{t1} \exp \left[-ct_2 \frac{\omega_t^2}{\Delta U^2} (d^2 + g_t^2) \right]$$

$$g_t = \min \left[0.1, \frac{\Delta U}{\omega \Delta x_t} \right]$$

and ΔU is the difference between the velocity at the field point and that at the trip (on the wall), Δx_t is the grid spacing along the wall at the trip, ω_t is the wall vorticity at the trip, d_t is the distance from the field point to the trip, $Ct_1 = 1$ and $Ct_2 = 2$.

The far field boundary condition is:

$$0 \leq \hat{v}_{farfield} < \frac{1}{10} v_\infty.$$

The turbulent eddy viscosity is computed from:

$$\mu_t = \rho v f v_1$$

where:

$$f v_1 = \frac{X^3}{X^3 + c_{v1}^3}$$

$$X = \frac{\hat{v}}{v}.$$

ρ is the density, $v = \frac{\mu}{\rho}$ is the molecular kinematic viscosity, and μ is the molecular dynamic viscosity. Additional definitions are given by the following equations:

$$\hat{S} = \Omega + \frac{\hat{v}}{k^2 d^2} f v_2$$

where $\Omega = \sqrt{2W_{ij}W_{ij}}$ is the magnitude of the vorticity, “ d ” is the distance from the field point to the nearest wall and

$$f v_2 = 1 - \frac{X}{1 + X f v_1}$$

$$f_w = g \left[\frac{1 + c_{w3}^6}{g^6 + c_{w3}^6} \right]^{\frac{1}{6}}$$

$$g = r + c_{w2} (r^6 - r)$$

$$r = \min \left[\frac{\hat{v}}{\hat{S} k^2 d^2}, 10 \right]$$

$$f_{t2} = c_{t3} \exp(-c_{t4} X^2) \quad \text{and,}$$

$$W_{ij} = \frac{1}{2} \left(\frac{\partial u_i}{\partial x_j} - \frac{\partial u_j}{\partial x_i} \right).$$

The value of constants is,

$$Cb_1 = 0.1355, Cb_2 = 0.622, Cv_1 = 7.1, Cw_2 = 0.3, Cw_3 = 2$$

$$k = 0.41, Ct_3 = 1.2, Ct_4 = 0.5, \sigma = 2/3$$

$$Cw_1 = (Cb_1/K^2) + (1 + Cb_2)/\sigma.$$

3. Numerical analysis and simulation

In order to do the simulation for this case by using appropriate numerical solver, a validated case study with sufficient quantitative and qualitative information about the flow-field created by muzzle blast is necessary to properly validate computational fluid dynamics (CFD) techniques. For this, a CFD analysis of the 7.62 mm NATO G3 rifle with DM-41 round was selected showing the flow-field in the form of shadow-graph [5, 6]. Fig. 1 is the validated CFD result using fluent.

Table 1. Specifications of 120 mm K1A1 tank gun.

Caliber (mm)	120
Pressure (psi)	80,000
Velocity (m/s)	1740
Ext. diameter (mm)	310
Total length (mm)	5600
Gross weight (Kg)	2725
Thickness of first baffle (mm)	95
Thickness of other baffles (mm)	50

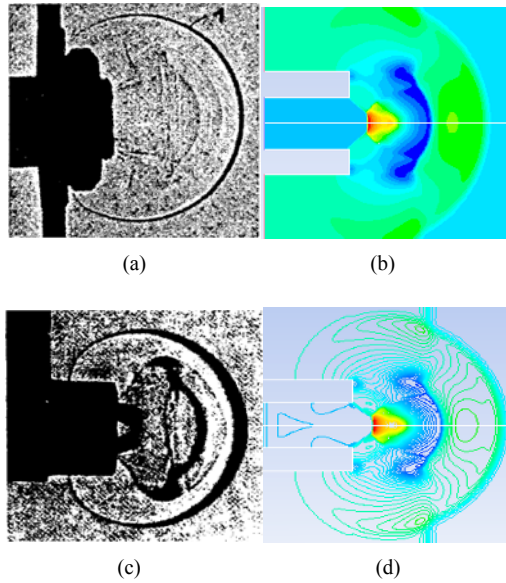

Fig. 1. (a) Reference shadow graph at $t_{exp} \approx 2.5e-3ms$; (b) CFD Pressure graph; (c) Reference shadow graph at $t_{exp} \approx 3.7e-3ms$; (d) CFD Pressure graph.

Also Fig. 2 shows the pressure graph at initial reference condition for 7.62 mm NATO, G-3 rifle.

CFD analysis has been applied to analyze the supersonic blast flow based on validated result. The basic domain has been made from the specifications and data of 120 mm caliber K1A1 tank gun barrel, which has shown in Table 1 and Fig. 3.

A density based axisymmetric, unsteady state condition with ideal gas as fluid has been used. First order implicit scheme is used for time integration and also the Spalart-Allmaras S.A (1-eqn) turbulence model is used. Additionally, the multi-block grid technique has been applied to construct the complicated geometry of the gun muzzle.

3.1 CFD for high pressure blast flow field without silencer

To investigate and analyze the high pressure supersonic blast flow with a silencer, first it is important to analyze the same case without installing silencer at the muzzle end of the gun. After that the achieved data is compared with the results achieved with silencer case. Fig. 4(a) and (b) show the schematic diagram of the computational domain, initial condition,

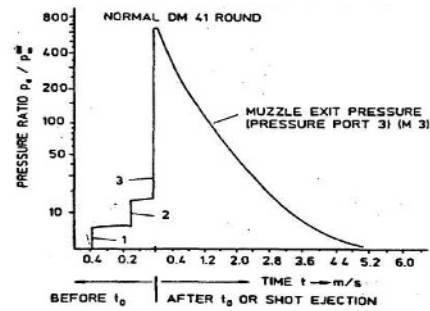

Fig. 2. Reference Pressure graph at initial condition for 7.62 mm NATO G3 rifle.

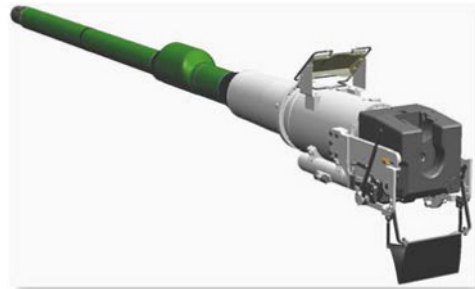

Fig. 3. Barrel mechanism of 120 mm K1A1 tank gun (Personal Fig).

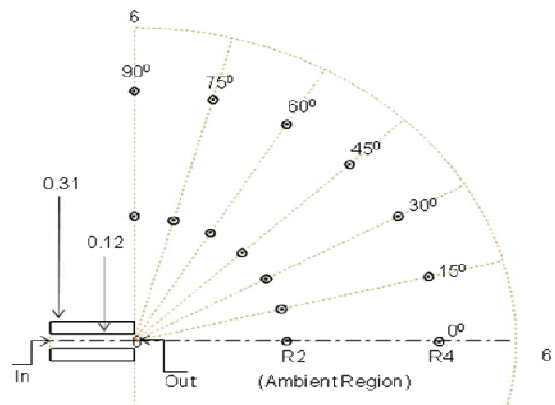

Fig. 4(a). Schematic diagram without silencer for 120 mm tank gun.



Fig. 4(b). Mesh diagram without silencer for 120 mm Tank Gun, (Mesh Size: 23655 cells, 47716 faces and 24062 nodes).

and boundary condition of 120 mm K1A1 gun without silencer and Fig. 5 shows the maximum pressure graph at inlet condition by using the data from Table 1.

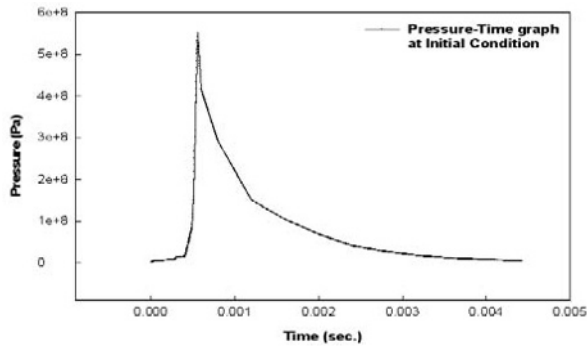

Fig. 5. Pressure-Time graph at inlet condition for 120 mm K1A1 tank gun.

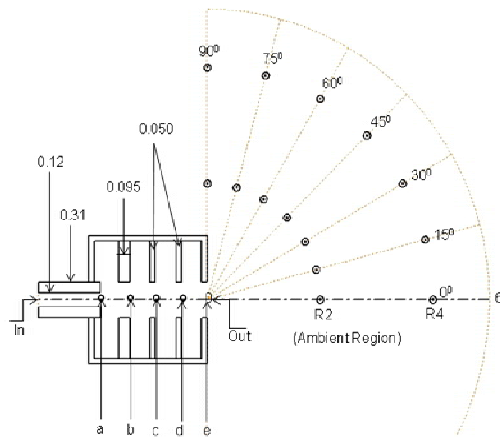

Fig. 6(a). Schematic and CFD animation diagram with three baffle silencer for 120 mm tank gun.

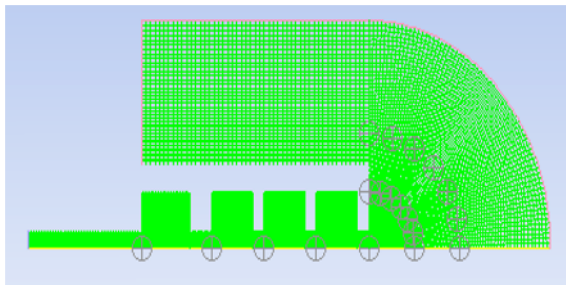

Fig. 6(b). Mesh diagram with three baffle silencer for 120 mm tank gun, (Mesh Size: 19648 cells, 39944 faces and 20297 nodes).

In order to get the impulsive sound pressure level in the open field area, different points have been taken at a radial distance of R2 and R4 from the muzzle end. These points have been taken at an angle of 0°, 15°, 30°, 45°, 60° and 90° as shown in Fig. 4(a).

3.2 CFD for high pressure blast flow field with silencer

The schematic diagram of computational domain, and meshing diagram for the 120 mm K1A1 tank gun after installing three baffle silencer shown in Fig. 6(a) and (b).

To get the comparison result of sound pressure level in the

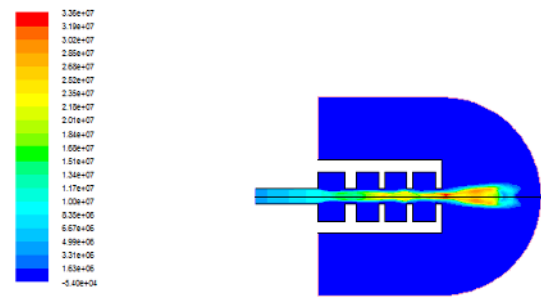

Contours of Total Pressure (pascal) (Time=4.4240e-03)

Fig. 7. Pressure contour diagram with three baffle silencer for 120 mm tank gun.

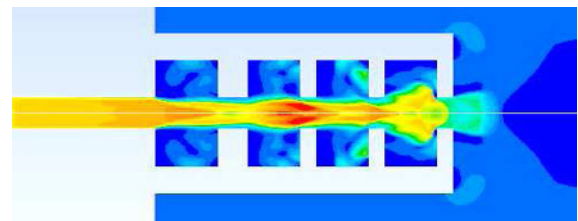

Fig. 8. Blast wave formation diagram inside the silencer.

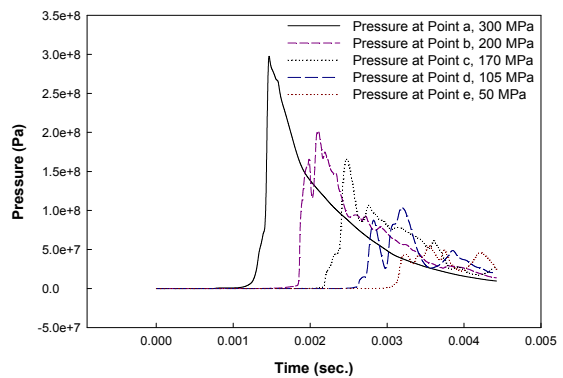

Fig. 9. Pressure graph at five different points inside the silencer.

ambient region after installing this silencer, all the points of measurement were taken at same distances and angles as above case. Detail has been shown in Fig. 6(a).

4. Results and discussion

CFD result of pressure contour diagram is shown in Fig. 7, whereas Fig. 8 shows the blast wave formation inside the silencer. Furthermore, Fig. 9 and Table 2 state the result of pressure variation and sound pressure level at points “a-e” due to propellant shock wave.

In view of the following results, it is concluded that, approximately 90% of pressure and 20 dB of sound pressure level have been attenuated due to use of the three baffle silencer.

Fig. 10(a)-(e) show the pressure graphs at different points with and without silencer, which have taken at different angle at a radial distance of R2 in the ambient region. Table 3 illustrates the results of pressure and sound level compared at these points.

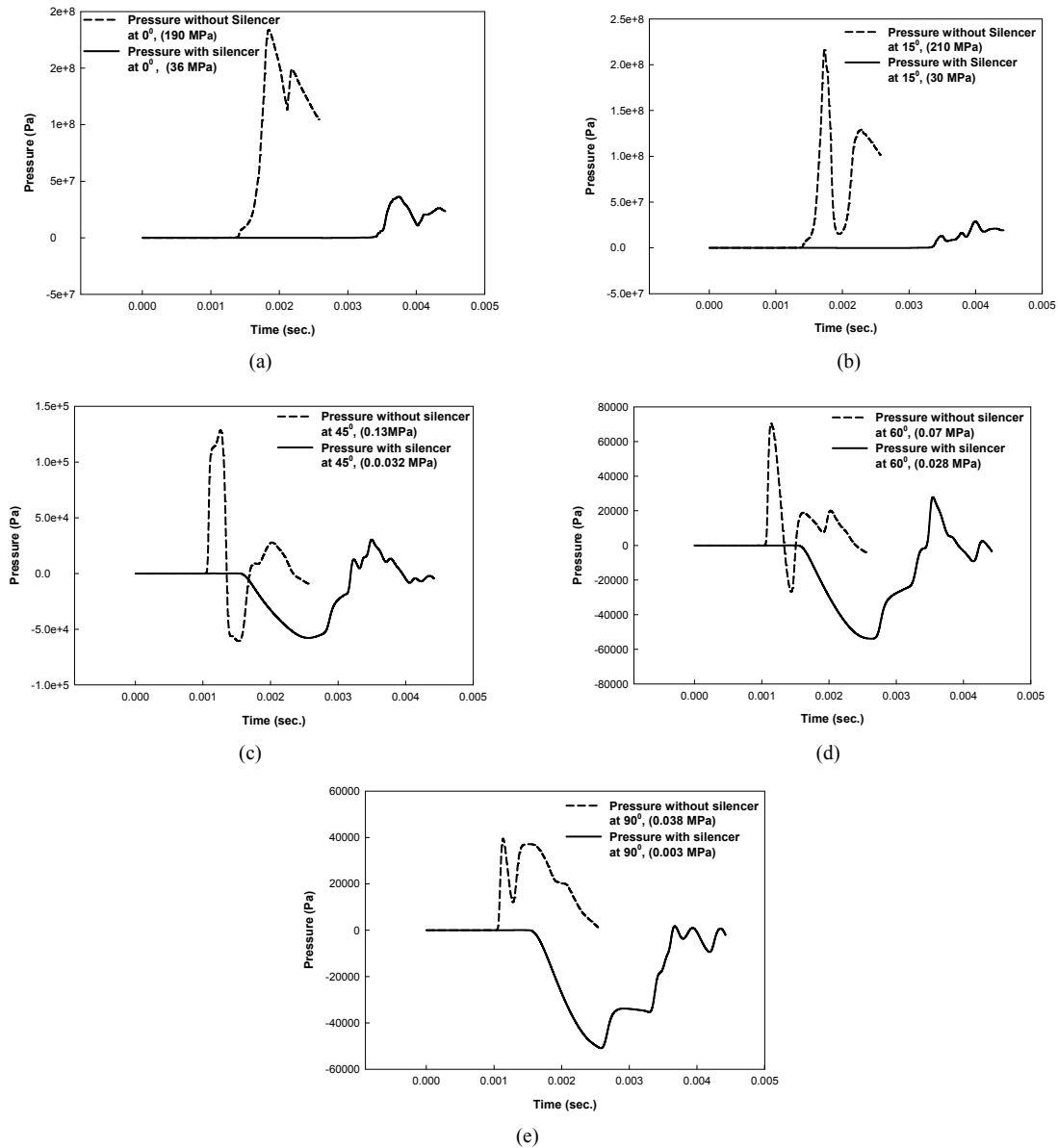

Fig. 10. Pressure at different points taken at a radial distance of R2 in the ambient region.

Similarly Table 4 shows the result of pressure and sound pressure level compared at the different points with and without silencer, at same angles but at a radial distance of R4 in the ambient region.

From Table 3, it is cleared that the reduction in pressure and sound level at R2, angle 0° is 82% and 14 dB, whereas at 90° the reduction is 92% and 22 dB. Similarly from Table 4, the reduction in pressure and sound level, recorded at point R4 angle 0° is 85% and 16 dB whereas at 90°, this reduction is 90% and 20 dB respectively.

5. Conclusions

The paper describes the CFD analysis of impulsive sound pressure and attenuation of sound pressure generated by large

caliber gun during firing. Due to use of three baffle silencer at the muzzle end of gun barrel, approximately 90% of pressure and 20 dB of sound level has been reduced, in comparison to the gun without silencer. The results of this study will be helpful to understand the blast wave characteristics as well as in designing of silencers for large caliber weapon system.

Acknowledgement

This research was financially supported by the Technology Innovation Project of Small and Medium Business Administration, and the National Research Foundation of Korea. Grant funded by Korean government (NRF-2010-013-D00007) and 2010 year research professor fund of Gyeong-sang National University, Korea.

Table 2. Pressure and sound pressure level at five points inside the silencer.

Locations	Maximum pressure (MPa)	Sound pressure level (dB)
Point -a	300	263
Point -b	200	260
Point -c	170	258
Point -d	105	254
Point -e	50	244

Table 3. Pressure and sound pressure level at different points at R2 in the ambient region.

Angle	Maximum pressure (MPa)		Sound pressure level (dB)	
	Without silencer	With silencer	Without silencer	With silencer
0°	190	36	259	245
15°	210	30	260	243
30°	35	0.11	244	194
45°	0.13	0.032	196	184
60°	0.07	0.028	190	182
90°	0.038	0.003	185	163

Table 4. Pressure and sound pressure level at different points at R4 in the ambient region.

Angle	Maximum pressure (MPa)		Sound pressure level (dB)	
	Without silencer	With silencer	Without silencer	With silencer
0°	175	26	258	242
15°	170	2.75	258	222
30°	0.51	0.049	208	187
45°	.057	0.022	209	180
60°	0.044	0.014	186	176
90°	0.020	0.002	180	160

Nomenclature

CFD : Computational fluid dynamics
 T : Static temperature, °K
 ρ : Density, kg/m³
 v : Velocity, m/s
 μ : Viscosity
 p : Pressure, Pa
 d : Distance, mm
 Ω : Magnitude of vorticity
 τ : Shear stress
 L_p : Sound level
 ω_t : Wall vorticity
 S : Entropy
 γ : Ratio of specific heat
 t_{exp} : Experimental flow time, ms

References

- [1] K. -J. Kang, S. H. Ko and D. S. Lee, A study on impulsive sound attenuation for high pressure blast flowfield (2007).
- [2] C. H. Cooke and K. S. Fansler, Numerical simulation and modeling of a muffler, (1989).
- [3] K. S. Fansler and R. Von Wahlde, A muffler design for tank cannon acceptance testing (1991).
- [4] L. L. Pater, T. G. Grubb and D. K. Delaney, Recommendation for improved assessment of noise impacts on wildlife, U.S. Army Engineering Research and Development Center.
- [5] D. L. Cler, N. Chevaugen, M. S. Shepherty, J. E. Flaherty and J.-F. Remacle, Computational fluid dynamics application to gun muzzle blast-a validation case study, Technical Report ARCCB- TR-03011 (2003).
- [6] D. L. Cler, Techniques for analysis and validation of unsteady blast wave propagation (August 2003).
- [7] K. S. Fansler and D. H. Lyon, Attenuation of muzzle blast using configurable mufflers, Memorandum Report BLR-MR-3931 (1989).
- [8] K. S. Fansler, C. H. Cook, William G. Thompson and David H. Lyon, Numerical simulation of a multi compartmented gun muffler and comparison with experiment (September 1990).



Hafizur Rehman is currently a graduate student, (M.D Course) in Department of Mechanical and Precision Engineering, Gyeongsang National University South Korea. Mr. Rehman did his Bachelor Degree in Mechanical Engineering, in 2001 from University of Engineering and Technology Khuzdar Baluchistan Pakistan.



Hyo-Min Jeong received his Ph.D degree from the University of Tokyo, Japan in 1992. Dr. Jeong is currently a Professor at the Department of Mechanical and Precision Engineering at Gyeongsang National University in Tongyeong, Korea. His research interests include Fluid Engineering, CFD, Cryogenic systems, Ejector systems, Mechanical Vapor Compression, and Cascade Refrigeration systems.



Han-Shik Chung received his Ph.D degree from Donga University, Korea in 1987. Dr. Chung is currently a Professor at the Department of Mechanical and Precision Engineering at Gyeongsang National University in Tongyeong, Korea. His research interests include Thermal Engineering, Heat Transfer, LNG Vaporizer Optimum, Solar Cells, and systems for producing fresh water from seawater.